

DATSUN 1000

**OWNER'S
MANUAL**



MODEL (V)B10 SERIES

NISSAN MOTOR CO., LTD.

TOKYO, JAPAN

Foreword

Your purchase of a Datsun places you in a distinguished family of automobile owners and drivers. The Datsun is a quality product built to satisfy exacting demands as to styling, performance and driving characteristics.

The purpose of this book is to acquaint you with Datsun features designed to add to your motoring pleasure.

Proper handling, maintenance, breaking-in and technical information are all provided to aid you in drawing full performance from your Datsun. Please read through this manual and keep it in the glove compartment so that you can readily refer to whenever necessary.

We hope you and your family enjoy many miles of high performance and care free driving in your Datsun.



Contents

	Page
1. INSTRUMENTS AND CONTROLS	1
2. KEYS	4
3. STARTING THE ENGINE	5
4. SHIFTING THE CONVENTIONAL DRIVE	5
5. NEW CAR BREAK-IN	6
6. SEATS, WINDOWS AND LOCKS	7
7. OPTIONS AND ACCESSORIES	11
8. HEATING AND VENTILATING	13
9. ELECTRICAL SYSTEM	15
10. WHEELS AND TIRES	19
11. COOLING SYSTEM	21
12. CHECKING AND ADJUSTMENTS	22
13. DAILY CARE	25
14. PERIODIC MAINTENANCE	26
15. RECOMMENDED LUBRICANTS	29
16. GENERAL SPECIFICATIONS	30
17. ENGINE AND CHASSIS NUMBER	33
18. WIRING DIAGRAM	34



INSTRUMENTS and CONTROLS

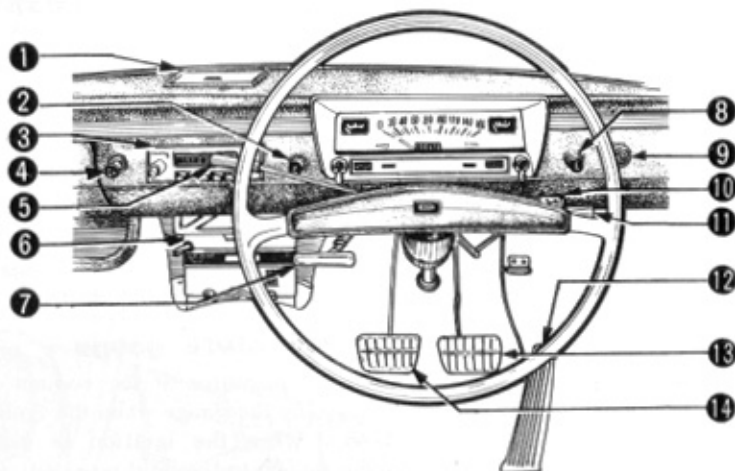

- 1 Ash tray
- 2 Choke control knob
- 3 Radio
- 4 Cigarette lighter
- 5 Shift lever
- 6 Heater
- 7 Hand brake
- 8 Light switch
- 9 Ignition switch
- 10 Washer switch
- 11 Turn indicator and head light beam selector lever
- 12 Accelerator pedal
- 13 Brake pedal
- 14 Clutch pedal

- 1 Fuel gauge
- 2 Turn indicator light
- 3 Heater fan control switch
- 4 Ignition warning light
- 5 Headlight beam warning light
- 6 Water temperature gauge
- 7 Turn indicator light
- 8 Wiper switch
- 9 Oil pressure warning light

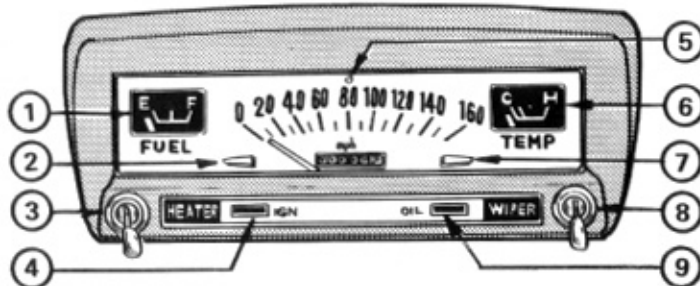

Datsun Factory Parts give greater satisfaction.

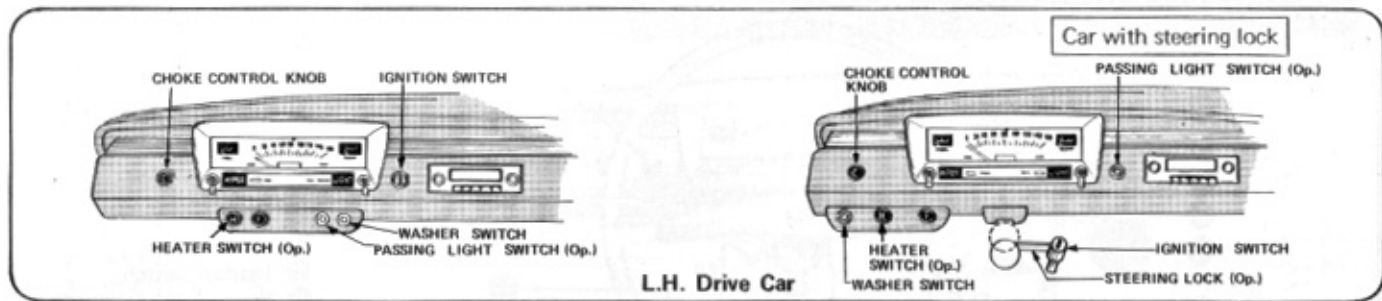

Fuel gauge

The fuel gauge indicates the quantity of fuel in the tank when the ignition is switched on.

Ignition warning light

With the ignition switch on the warning light should be illuminated only when the engine is stopped or is running very slowly.

As engine speed increases, the light should dim and eventually go out at a fairly low engine speed. If the light does not go out, check the fan belt or other parts of the electrical system.

Water temperature gauge

The temperature of the coolant is electrically indicated by the gauge when the ignition is switched on. When the ignition is switched off, the needle moves to the cold position.

Oil pressure warning light

The light glows when the ignition is switched on and fades out after the engine has been started. However, if the light remains on while driving, stop the engine immediately and check the oil level or lubrication system.

Two speed wiper switch

This is a tumbler type switch with two positions.



Light switch

This is a pull-type switch with two positions. The first position controls the instrument lights as well as the tail, number-plate and parking lights. The second stage controls the head lights.

TURN INDICATOR & HEAD LIGHT BEAM SELECTOR LEVER

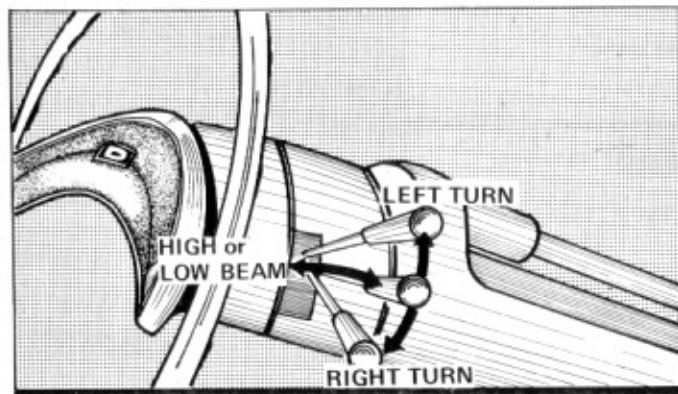

Passing light switch (Optional for L.H. Drive)

By pushing in and releasing the passing light switch, the high beams of the head lights will be turned on and off.

Ignition switch

This three position switch, operated by the shield-shaped key, controls the engine ignition system and most of the electrical equipment in your car.

The ignition switch combined with the steering lock device is optionally available for L. H. drive car. In this switch "ACC" position is included and all accessories can be operated when the key is in the "ACC" position without the engine running.

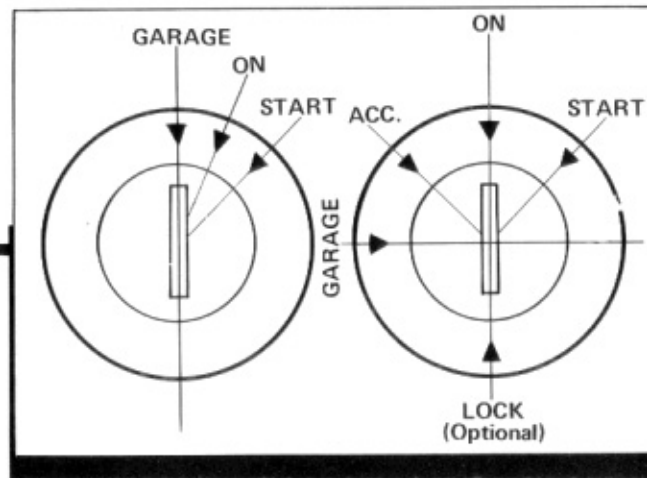

KEYS

A single key operates the various locks on your Datsun.

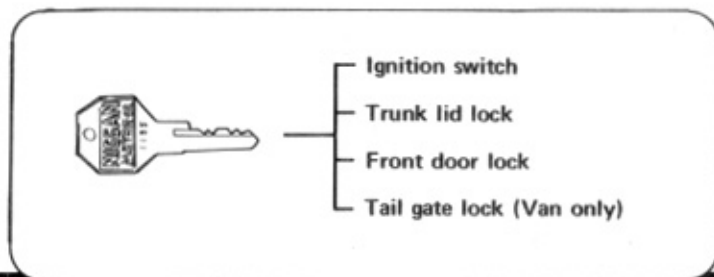

When the optional steering lock device is installed on your car, two different keys are provided.

Record these key numbers. They enable your DATSUN dealer to replace lost keys.

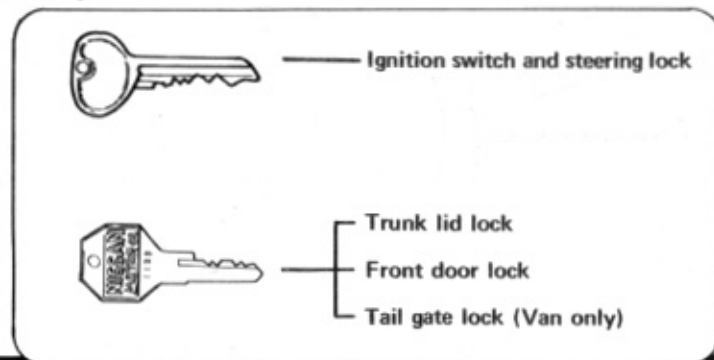

STARTING the ENGINE

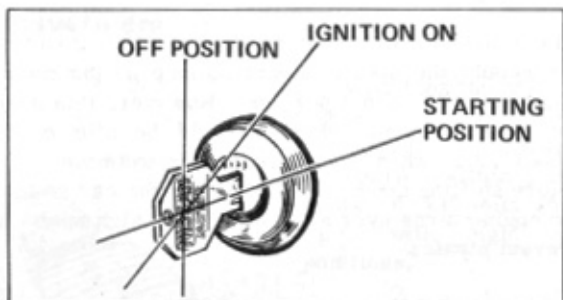

Place the gear shift lever in neutral position.
Turn on the ignition switch and see if the oil pressure and ignition warning light glow. Then turn the key further. As soon as the engine starts, release the key.

Cold engine -- Pull out the choke control knob and do not depress the accelerator pedal. As soon as the engine starts, release the key. Push in the choke knob after the engine has warmed up enough to run on a normal fuel mixture.

SHIFTING the CONVENTIONAL DRIVE

Synchromesh is provided on all the forward gears.

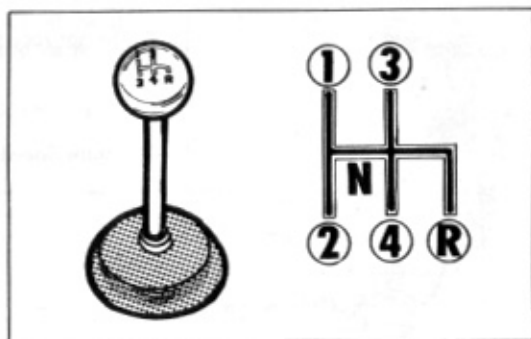
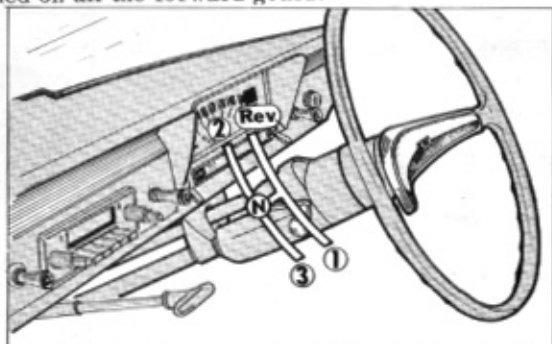

NEW CAR BREAK-IN

Every new car requires a certain breaking-in period during which it should be driven with care. Pistons, cylinder bores and bearings need to be in operation for some time before they produce smooth and long-wearing surfaces. Placing too much strain on a new engine impedes this gradual bedding down process and is likely to shorten its working life. During the first 3,000 km (2,000

miles) the car must not be driven at full throttle, nor should the speed exceed 56 m. p. h. (90 km/h) except for very short periods. However, this does not mean that the engine should be allowed to labour when going uphill, for example before shifting down. Always drive the car so that the engine turns over at a sufficiently high speed to prevent strain.

- * Avoid driving with full throttle for the first 2,000 miles.
- * Do not allow the engine to labour in any gear.
- * Do not race the engine.

Maximum Speed Limit for the first 3,000 km (2,000 miles)

	1st	2nd	3rd	4th
3-forward type	25 km/h (16 MPH)	50 km/h (31 MPH)	90 km/h (56 MPH)	_____
4-forward type	23 km/h (14 MPH)	40 km/h (25 MPH)	62 km/h (39 MPH)	90 km/h (56 MPH)

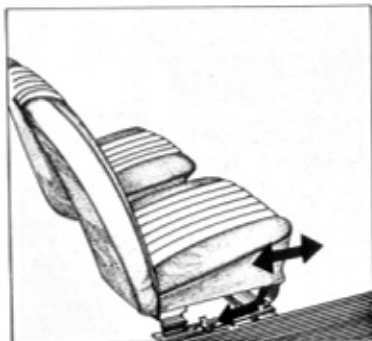
Seat adjustment

By pushing the adjusting lever backward you can move it forward and backward within the range of 140 mm (5.5 in.), with eight set positions.

Reclining seat (deluxe type)

You can get your fitting position of the seat back by lifting up the lever.

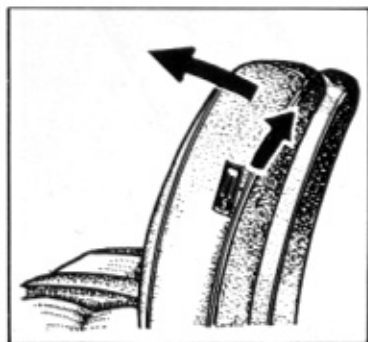
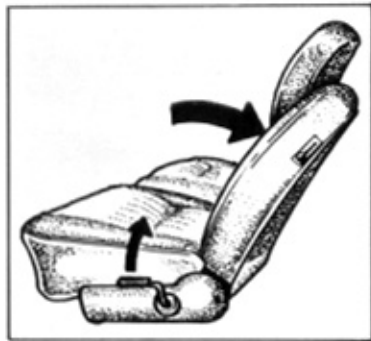

Tilt the front seat by lifting up the safety lock lever. (2 door car)

Tilt the front seat by lifting up the safety lock lever. (2 door car Deluxe type)

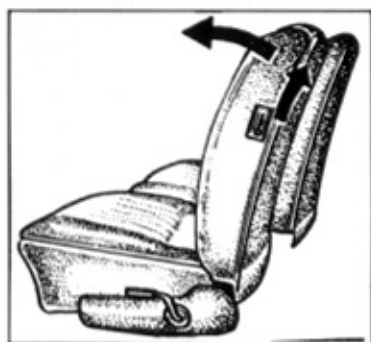

Rear seat conversion(Van only)

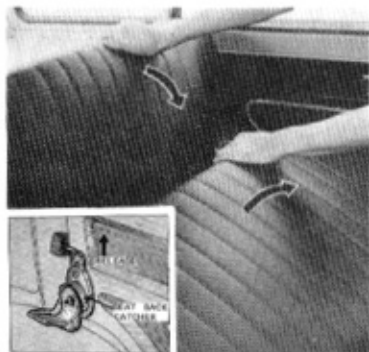

To fold down the rear seat, release the lock at the seat back catcher and fold down the seat as shown in the figure.



Then fix the seat cushion with the fixing band as shown in the figure.

Ventilator

To open the ventilator, push the button. Turn the lever forward and move the ventilator out to the desired position.

To close, pull the ventilator in and turn the lever backward.

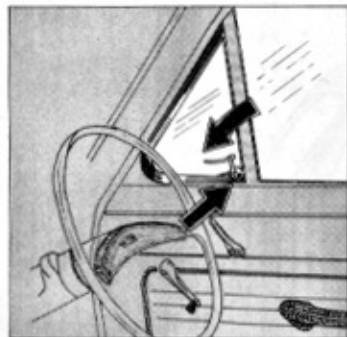

Rear side window (2 door car)

The rear side window can be partly opened by operating the lever.

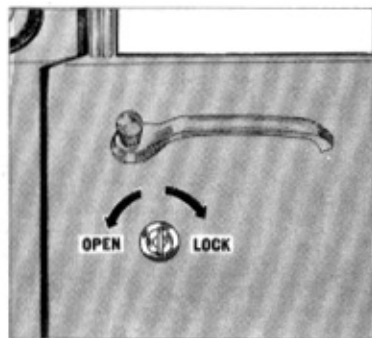

Door locks

To lock the door, insert the key and turn it toward the front of the car.

Turn the key toward the rear of the car to unlock the door.

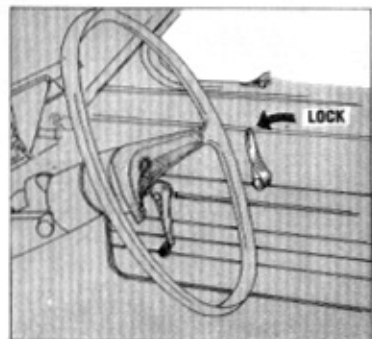

The doors can also be locked by turning the inside handle forward.

Rear door locks(4 door car)

The rear doors can be locked by turning the inside handle forward.

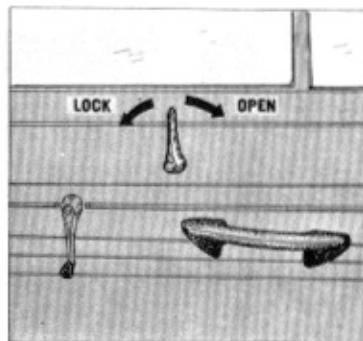

As a safety feature for children, the special locks are provided at the rear doors on 4 door model. When you close the door applying the lock, you can not open the door from inside and the door will be opened from outside.



To open the hood

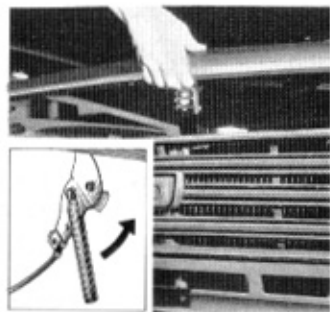

Pull the hood lock handle located at the lower right-hand side of the instrument panel, and then the safety catch, located under the center edge of the hood, must be pushed up to completely release the hood.

Hood support

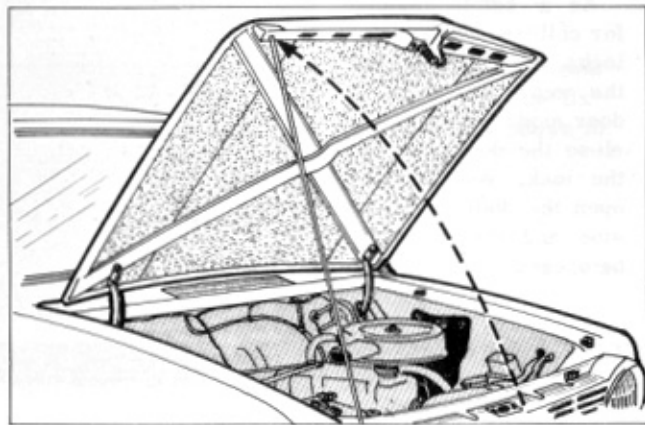

Trunk lid lock

To open the lid, insert the key and turn it clockwise.

To close, just push shut.



Fuel Filler cap lock

To open, insert the key and turn it counter-clockwise.

To close, turn it clockwise.

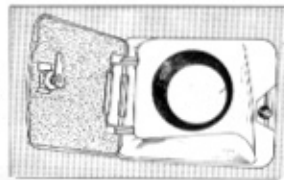

Radio(Optional)

The radio has five push buttons for station selection. Other stations may be be selected by the manual tuning knob.

Adjust the push buttons as follows

1. Pull the selector button straight out until it stops, tune in the station you want with the manual tuning knob.
2. After the station is clearly tuned in, push the selector button straight in until it stops, and then release it.

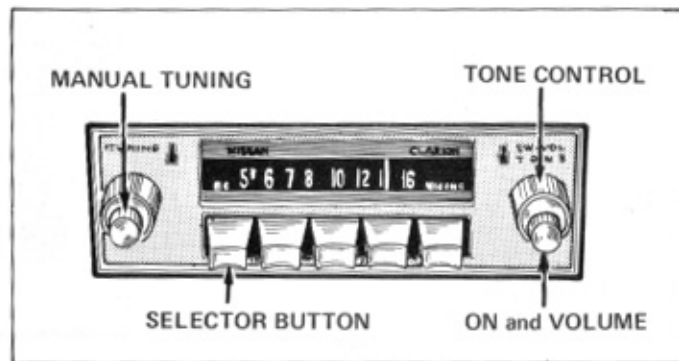

Clock(Optional)

To correct the time, push the knob and turn it clockwise.

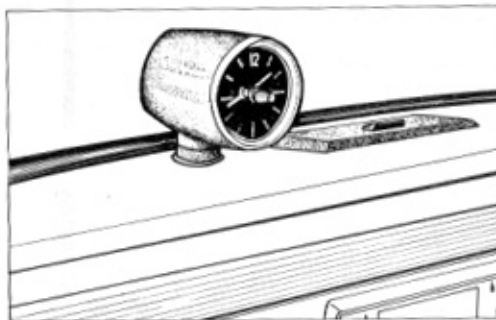

Package tray

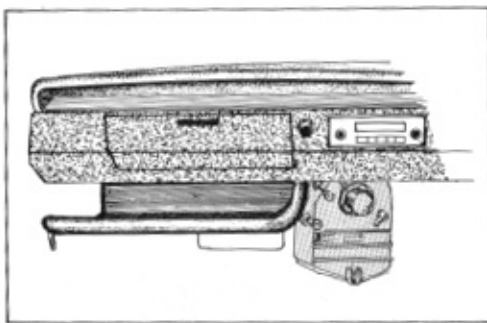

OPTIONS and ACCESSORIES

Ash tray

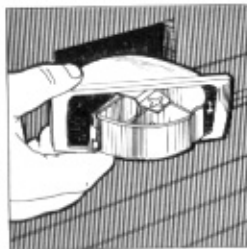
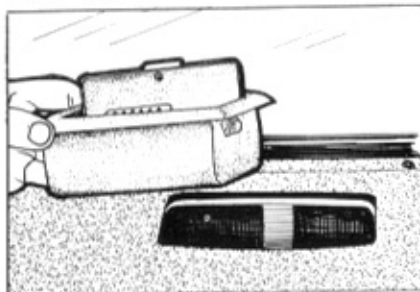

2 door sedan



4 door sedan

Cigarette lighter

Press in the knob.

It will stay in this position until the lighter element is at the correct temperature, then it will pop back into its former position.

It should then be pulled completely out of its holder for use.



Glove compartment

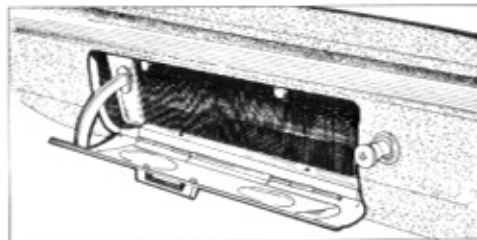

Ash trays, installed in the center of the dashboard and in both sides of the rear seat, can be removed for cleaning. For 4 door sedan a rear ash tray is installed at the seat back of driver's side.

Safety seat belt (Optional)

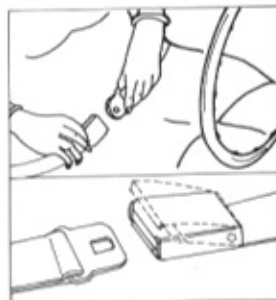

Insert to connect.
Lift to release.

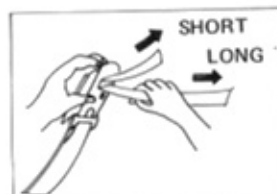

Pull to lengthen or shorten with the buckle in vertical position.

The operation of the heater-ventilator system is controlled by fan control switch, temperature control switch, air vent knob, heater air control knob and room and defroster control knob.

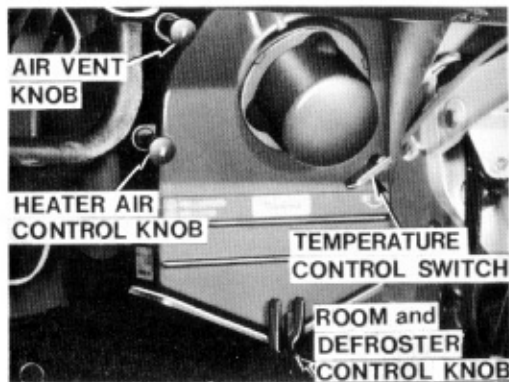
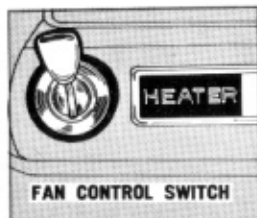

To ventilate the car

By pulling the air vent knob with the temperature control switch and room and defroster control knob in "OFF" position. You can get fresh air directly into the interior.

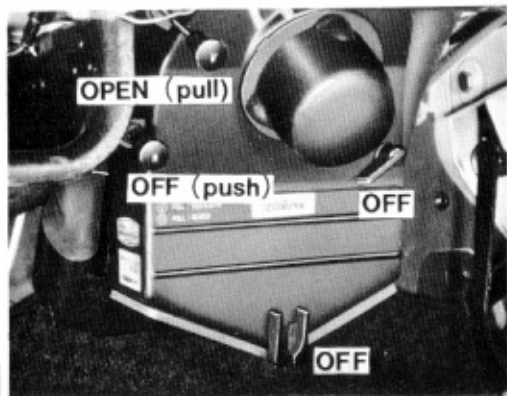

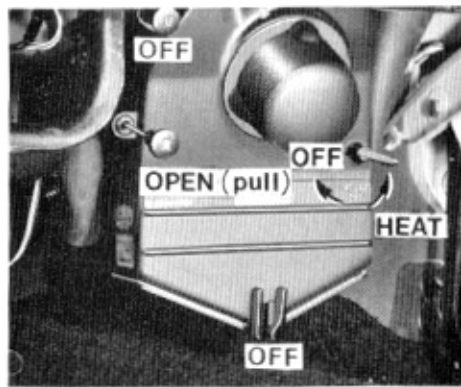
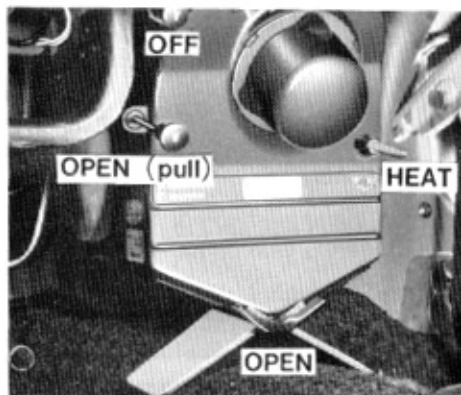

To heat the car

- 1) Close the air vent lit.
- 2) Turn the temperature control switch to "Heat" position.
- 3) Pull the heater air control knob.
- 4) Turn on the fan control switch on the instrument panel.
- 5) Turn the room and defroster knob to the "Room" position.

To defrost the windshield

- 1) Operate the heater in the same way.
- 2) Turn the room and defroster knob to the "Defroster" position.

To defog the windshield

Use same procedure as for defrosting action except turn the temperature control switch to the "OFF" position.

Head lights

To change the sealed beam units,
remove

- Rim
- three screws which attach the lamp assembly

Whenever a sealed beam is replaced, the head light should
always be checked for alignment and adjusted.

[12V - 50/40W]

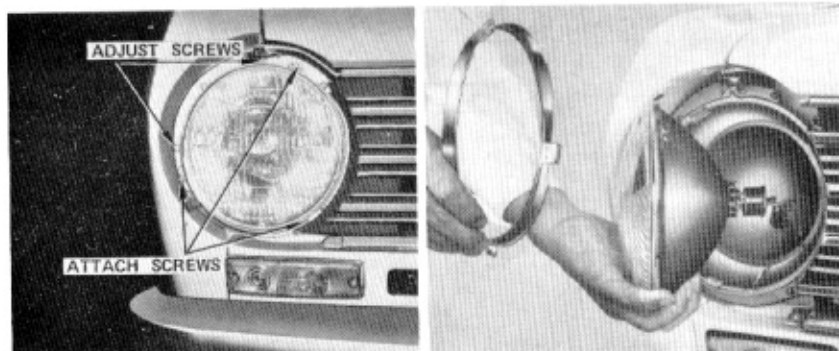

Directional and parking light (Front)

Remove the two screws and
replace the bulb.

[12V - 8/25W]



Tail and stop lights, directional lights

Remove the socket by turning it counter-clockwise at inside luggage compartment, and then replace bulbs.

Directional lights [12V - 8/25W]

Stop lights [12V - 8/25W]

Back-up lights [12V - 25W]

(Sedan)

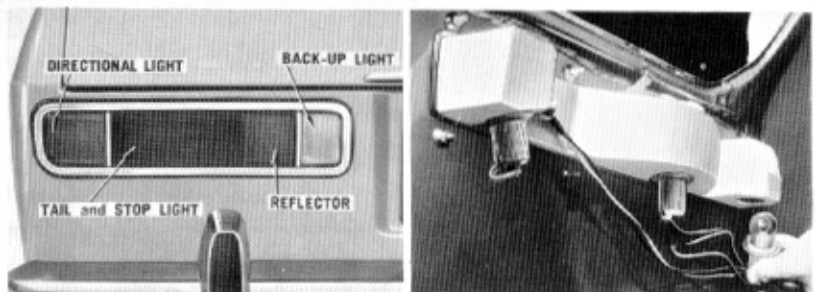

Licence plate light

Remove the two screws.
Press down the bulb, turn it counter-clockwise, and remove.

[12V - 10W]

(Van)

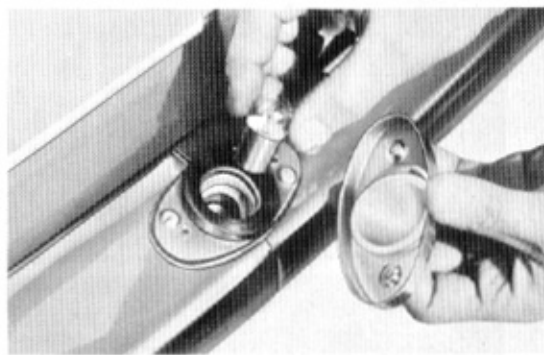
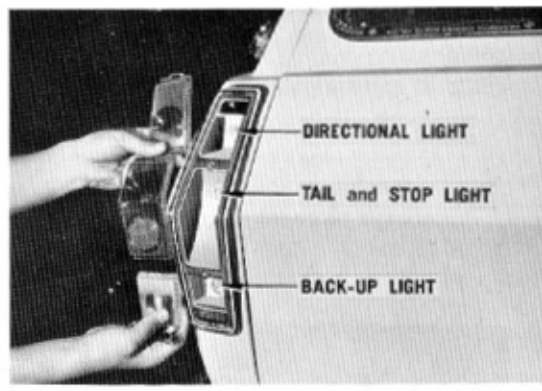

Room light

Pull out the cover.
 Replace the bulb by pushing and turning it counter-clockwise.

[12V - 6W]

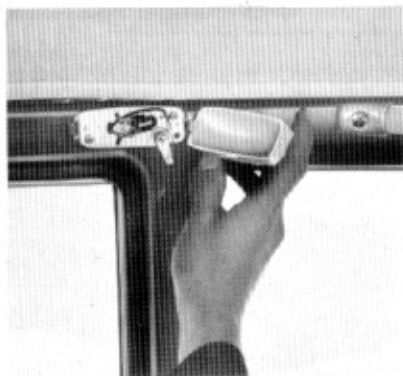
**Side Flasher lights**

Turn and remove the wing nut at the back of fender panel. The bulb socket can then be removed.

Press down the bulb and turn to remove.

[12V - 6W]

**Fuses**

Fuses are located in the engine well.

If a fuse needs to be replaced, refer to the specifications listed on the back of the fuse box cover.

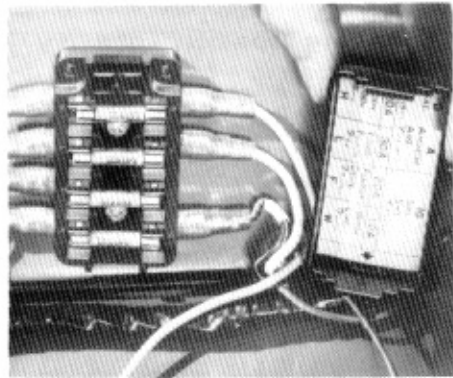

Battery

Check the electrolyte level in the battery about once a month to prevent the battery from going dry. If necessary add distilled water to bring the level up approximately 5 mm above the plates. Do not overfill.

To prevent corrosion and leakage of current keep the top of battery clean and dry. Also keep the terminals clean and well covered with petroleum jelly.



Checking specific gravity

Check the specific gravity of electrolyte in each of the cells by hydrometer. Specific gravity should be as follows.

	Full charged specific gravity (at 68°F, 20°C)
Frigid climates	1.28
Tropical climates	1.23
Other climates	1.26



Performance, ride and handling qualities of any car are greatly influenced by tire condition and pressure. Tire pressure lower than recommended will reduce tire life and ride qualities. Pressures above those recommended affect the

life and comfort factor of the vehicle adversely, because "hard" tires tend to magnify, rather than absorb, road shocks and are more vulnerable to damage from striking depressions or blunt objects on the road.

Recommended tire pressure

Front	Sedan and Van	1.2 kg/cm ² (17 lbs/sq.in.)
Rear	Sedan	1.2 kg/cm ² (17 lbs/sq.in.)
		1.4 kg/cm ² (20 lbs/sq.in.) for reduced load, 15 kg (330 lbs) or less
	Van	2.5 kg/cm ² (36 lbs/sq.in.) for maximum load

For driving at high speeds pressures should be 0.3 kg (4 pounds) higher than recommended pressures.

Tire Rotation

To equalize tire wear, tires should be rotated every 10,000 km (6,000 miles) as shown in the diagram.

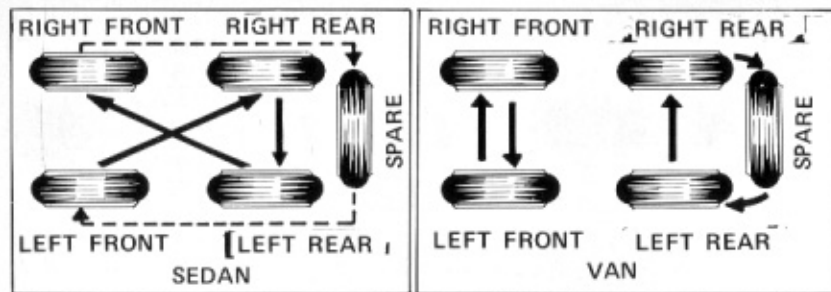

WHEELS and TIRES

Changing wheels

To change a tire and wheel, first apply the parking brakes and place tire stoppers under the wheels. There are four jack-up points on the floor panel.

Place the jack under the jack-up point.

Raise the car until the wheel clears the ground.

Remove wheel nuts, replace wheel and tighten nuts evenly.



Spare tires and tools

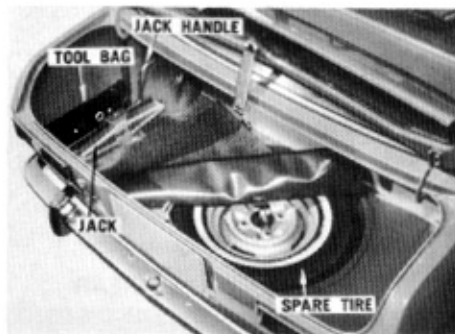

(Sedan)



(Van)



A pressurized, cooling system is used.
Check should be made periodically to ensure that there has been no loss of coolant due to leakage.
However, do not check the coolant while the system is hot.
Change the coolant every 10,000 km (6,000 miles).



Idling adjustment

Adjust the idling speed to about 600 rpm with both the throttle adjusting screw and the idle adjusting screw.



Fan belt

When it is necessary to check the fan belt tension, loosen the generator adjusting link bolt and adjust the tension by moving the generator.

Push the belt between the generator and the fan pulley, and adjust it to achieve a movement of 13 to 15 mm (0.5 to 0.6 in.).

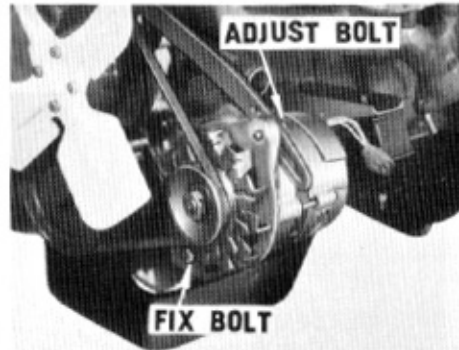
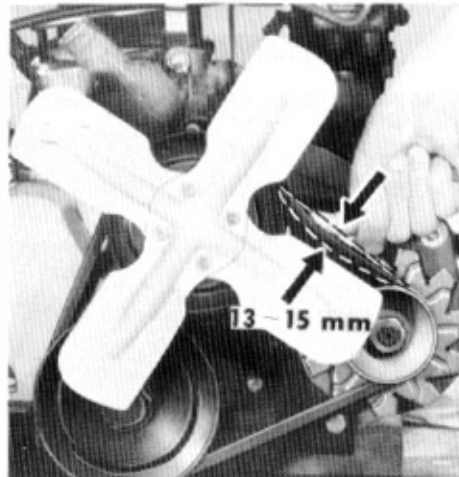

Oil filter

After the first 3,000 km (2,000 miles) of driving, drain and refill with an oil of the proper viscosity for the prevailing temperature.

Refer to the chart in "Engine oil recommendation".

At this first change, the oil filter cartridge should be removed and replaced with a new one.

This cartridge must be renewed every 10,000 km (6,000 miles).

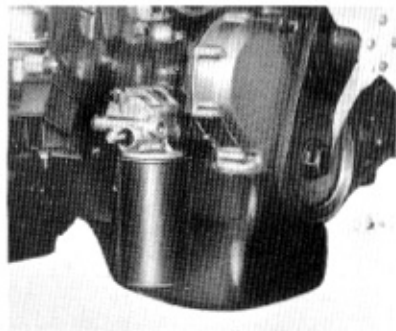

Fuel strainer

The fuel strainer is of the cartridge type and should be replaced at intervals not to exceed 24,000 miles (40,000 km).

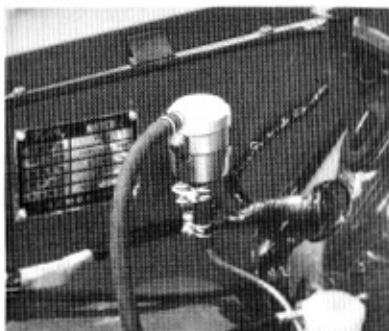

Air cleaner

The element is of the paper filter or viscous type. Since it has been specially treated there is no need to clean it but it should be replaced every 40,000 km (24,000 miles) under normal condition.

Although the element may look very dirty, if you try to clean it, you will make it less efficient as the filter paper is easily damaged.



Spark plugs

The spark plugs should be checked every 5,000 km (3,000 miles) and replaced every 20,000 km (12,000 miles), if the engine misses, is hard to start, or if fuel economy decreases.

Electrode gap 0.7 ~ 0.8 mm
(0.028 ~ 0.031 in.)

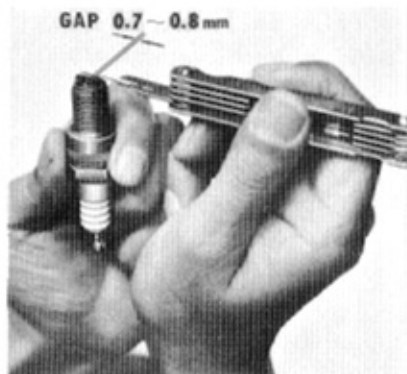

Checking contact points

Contact points and gap should be inspected every 5,000 km (3,000 miles).

Be sure that the contact surfaces are clean and not so burned that they must be replaced. The correct gap of 0.45 ~ 0.55 mm (0.018 ~ 0.022 in.) should be checked with a feeler gauge.

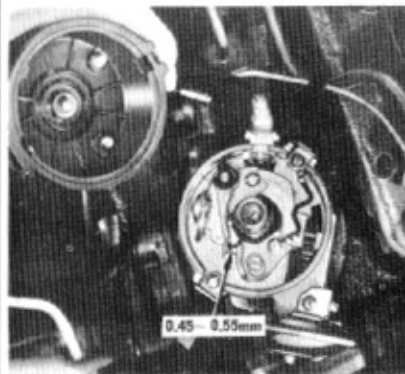

Ignition timing

The distributor is one of the most sensitive units in the engine so that the ignition timing setting should be checked at an authorized dealer.

To increase spark advance rotate the distributor clockwise.

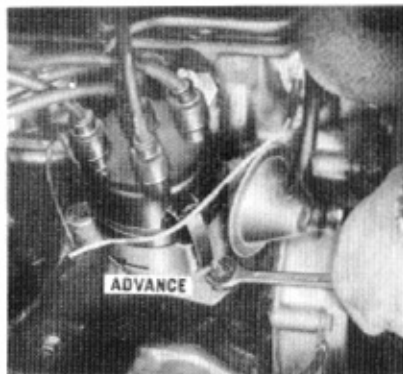

Before driving or whenever you go to a gas-station, be sure to check the following items.

1. Check the radiator coolant.
2. Check the engine oil.
3. Check the battery.

Unscrew each filler cap and check the fluid level. If necessary add distilled water to bring the level up to approximately 5 mm above the plate.

4. Check tire pressure, wear and scars.

Recommended tire pressure (front & rear) 1.2 kg/cm² (17 lbs/sq. in.).

5. Check directional indicators, horn and all lights and switches for proper operation.
6. Check the windshield washer fluid level.
7. Check leakage and amount of fluid in brake and clutch master cylinders.
8. Check clutch and brake operation.
9. Check steering wheel play.



PERIODIC MAINTENANCE

To assure satisfactory performance of your car, be sure to have the periodic checks carried out at an authorized dealer.

LUBRICATION CHART

MAINTENANCE FREQUENCY EVERY					LUBRICATION	MAINTENANCE PERIODS											
50000 km (30000 mile)	40000 km (24000 mile)	20000 km (12000 mile)	10000 km (6000 mile)	5000 km (3000 mile)		1000 km (600 mile)	3000 km (2000 mile)	6000 km (4000 mile)	10000 km (6000 mile)	15000 km (9000 mile)	20000 km (12000 mile)	25000 km (15000 mile)	30000 km (18000 mile)	35000 km (21000 mile)	40000 km (24000 mile)	45000 km (27000 mile)	50000 km (30000 mile)
				●	Engines	●	●	●	●	●	●	●	●	●	●	●	●
		○								○				○			
				○	Gear oil		○	○	○	○	○	○	○	○	○	○	
●						●										●	
	○									○				○			
	○									○		○		○		○	
			○					○		○		○		○		○	
●		●								●				●			
●																●	
			●													●	
●											●			●			
	○										●			○			
	○													○			
	○													○			
		○								○				○			
●					Fluid									○			
			●											●			
								●		●		●		●		●	

○ - Clean, check, adjust or supply

● - Change



CHECKING CHART I

MAINTENANCE FREQUENCY EVERY					CHECKING POINTS (ENGINE)	MAINTENANCE PERIODS											
50000 km (30000 mile)	40000 km (24000 mile)	20000 km (12000 mile)	10000 km (6000 mile)	5000 km (3000 mile)		1000 km (600 mile)	3000 km (2000 mile)	6000 km (4000 mile)	10000 km (6000 mile)	15000 km (9000 mile)	20000 km (12000 mile)	25000 km (15000 mile)	30000 km (18000 mile)	35000 km (21000 mile)	40000 km (24000 mile)	45000 km (27000 mile)	50000 km (30000 mile)
			○		Adjust valve clearance	○		○		○		○		○		○	
			○		Check ignition timing (adjust if necessary)	○		○		○		○		○		○	
			○		Check fan belt tension	○		○		○		○		○		○	
	○				Measure compression pressure												
	●				Change air cleaner element (Viscous type)											●	
	○				Check fuel line for leak		○									○	
	●				Change cartridge type fuel strainer											●	
	○				Check fuel pump for proper function											○	
					Retighten carburetor & fitting parts		○										
				○	Overhaul carburetor												
			●		Change oil filter		●		●		●		●		●		●
		○			Check battery specific gravity	○				○							
		●	○		Check (or change) spark plugs		○		○	●		○		●		○	
				○	Check distributor breaker point		○	○	○	○	○	○	○	○	○	○	○
	○				Check condenser for proper function												
		○			Check alternator, regulator for proper function												
		○			Check starter for proper function												
			○		Check engine for oil and water leaks	○		○		○		○		○		○	
		○			Retighten cylinder head, manifolds & exhaust pipe flange	○				○				○			
		○			Check for weak or damage of engine mountings												
					Retighten engine mountings	○											
			○		Adjust idling speed		○		○		○		○		○		○
			○		Check engine starting condition, abnormal noise and exhaust color		○		○		○		○		○		○
			○		Check high tension cable				○		○		○		○		○
			○		Clean ignition coil, distributor and battery				○		○		○		○		○

PERIODIC MAINTENANCE

CHECKING CHART II

MAINTENANCE FREQUENCY EVERY					CHECKING POINTS (CHASSIS, BODY)	MAINTENANCE PERIODS											
30000 km (30000 mile)	40000 km (24000 mile)	20000 km (12000 mile)	10000 km (6000 mile)	5000 km (3000 mile)		10000 km (6000 mile)	30000 km (20000 mile)	60000 km (40000 mile)	100000 km (60000 mile)	150000 km (90000 mile)	200000 km (120000 mile)	250000 km (150000 mile)	300000 km (180000 mile)	350000 km (210000 mile)	400000 km (240000 mile)	450000 km (270000 mile)	500000 km (300000 mile)
					Check clutch & brake pedal free play	○											
				○	Check clutch & brake system for oil leak or defect	○											
			○		Check clutch operation		○										
				○	Check foot & hand brake operation		○										
○					Check brake drum for wear												○
	○				Check drum brake lining												
					Overhaul master cylinder, wheel cylinder & caliper assembly												
				○	Check steering wheel free play	○	○	○	○	○	○	○	○	○	○	○	○
				○	Retighten steering gearbox												
				○	Check steering linkage for loose connection	○	○	○	○	○	○	○	○	○	○	○	○
				○	Retighten steering idler box												
				○	Retighten steering knuckle arm												
				○	Retighten leaf spring U bolt												
			○		Check and retighten front and rear suspension parts		○		○			○					○
			○		Check hydraulic shock absorber		○										
			○		Check wheel alignment and turning angle												
○					Check wheel bearing for wear												
			○		Rotate wheel position												
			○		Check wheel disc for damage												
			○		Measure wheel balance (correct if necessary)												
			○		Retighten propeller shaft universal joint flange		○										
			○		Check propeller shaft spline and joint for wear or damage												
			○		Retighten transmission case and differential carrier												
	○				Check exhaust pipe & muffler fitting parts												
○					Check transmission control linkage for proper operation												
			○		Check wire harness and contact parts												
			○		Retighten door hinge, lock & striker (align door if necessary)												
○					Check headlight aiming												
			○		Road test	○			○	○	○	○	○	○	○	○	○

○= Clean, check, adjust or supply

○= Change

RECOMMENDED LUBRICANTS

It is important to remember that satisfactory motor operation and performance largely depend on proper lubrication of the vehicle.

Temperature	°F	Under 10	10 — 32	32 — 90	Over 90	Lubricating Points
	°C	Under -12	12 — 0	0 — 32	Over 32	
Engine Oil		SAE 10W, 10W-30 (MS)	SAE 10, 10W-30 (MS)	SAE 20,20W,10W-30 (MS)	SAE 20, 10W-30 (MS)	Engine
Gear Oil	API GL-4	SAE 80 (MP)	SAE 90 (MP)	SAE 90 (MP)	SAE 140 (MP)	Transmision, Steering
	API GL-5	SAE 80 (MPS)	SAE 90 (MPS)	SAE 90 (MPS)	SAE 140 (MPS)	Diff.

	TEXACO INC.	CHEVRON OIL CO.	CALTEX	MOBIL.	SHELL	ESSO	BP (British Petroleum)	CASTROL	
Engine Oil	Multi grade	Havoline Motor Oil 10W-30,20W-40	RPM Supreme Motor Oil 10W-30,20W-40	Five Star Motor Oil 10W-30,20W-40	Mobiloil Special (10W-30)	Shell X-100 10W-30,20W-40	Esso Extra Motor Oil 10W-30,20W-40	BP Super Viscostatic Motor Oil 5W-20,10W-30	Castrolite 10W-30 Castrol XL20W-40
	Regular (Single grade or double grade)	Havoline Motor Oil 10W,20W-40,30,40	RPM Special Motor Oil 10W,20W-20,30,40	Five Star Motor Oil 10W,20W-20,30,40	Mobiloil 10W Arctic (20) AF (40) A (30) BB (50)	Shell X-100 20W,10W,20,30,40,50	Esso Motor Oil 20W-30,10W,40,50	BP HD Motor Oil 10W,20W,30,40,50	Castrol 5WHD 10WHD 20W-20HD 30HD,40HD,50HD
Gear Oil	API GL-4	Universal Gear Lubricant EP80,90	RPM Multi-Service Gear Lubricant 80,90,140	Universal Thuban 80,90	Mobilube GX80,90,140 Mobilube EP80-90,90,140	Spirax 80EP, 90EP, 140EP	Esso Gear Oil GP80,90,140	BP Gear Oil 80EP,90EP,140EP	Castrol Hypoy 80 Castrol Hypoy 90
	API GL-5	Multi gear Lubricant EP80,90,140	RPM Universal Gear Lubricant 80,90,140	Multi Purpose Thuban EP80,90,140	Mobilube HD80-90,90,140	Spirax HD80,90,140	Esso Gear Oil GX80,90,140	BP Hypogear 90 Universal	Castrol Hypoy B90
Multi Purpose grease	Marfak All Purpose Grease Marfak Multi Purpose Grease	RPM Multi-Motive Grease	Marfak All Purpose Grease Marfak Multi Purpose Grease	Mobil Grease MP	Retinax A	Esso multi Purpose Grease	BP Energrease 12	Castrolase LM	
Brake fluid (SAE 70R3)	Texaco Brake Fluid Super Heavy Duty	Atlas Extra HD Brake Fluid 400	Caltex Brake Fluid Super Heavy Duty	Mobil Super Heavy Duty Brake Fluid	Shell Donax B	Esso Hydraulic Brake Fluid Heavy Duty 400	BP Brake Fluid	Castrol HD	
Anti-Freeze	Anti Freeze Coolant	Atlas Perma-Guard Anti-Freeze and Coolant	Anti-Freeze Coolant	Mobil Freezezone	Shellzone Shell Anti-Freeze	Atlas Perma-Guard Anti-Freeze and Coolant		Castrol Anti-Freeze	



Datsun Factory Parts give greater satisfaction.

GENERAL SPECIFICATIONS

Dimensions

	B10 (2 door)	B10F (4 door)	VB10
Wheel base	2,280 mm (89.8 in.)	2,280 mm (89.8 in.)	2,280 mm (89.8 in.)
Overall length . (with over riders)	3,820 mm (150.4 in.)	3,820 mm (150.4 in.)	3,820 mm (150.4 in.)
Overall width	1,445 mm (56.9 in.)	1,445 mm (56.9 in.)	1,445 mm (56.9 in.)
Overall height	1,345 mm (53.0 in.)	1,345 mm (53.0 in.)	1,385 mm (54.5 in.)
Track - front	1,190 mm (46.9 in.)	1,190 mm (46.9 in.)	1,190 mm (46.9 in.)
- rear	1,180 mm (46.5 in.)	1,180 mm (46.5 in.)	1,180 mm (46.5 in.)
Turning radius	4.9 m (13.1 ft.)	4.0 m (13.1 ft.)	4.0 m (13.1 ft.)
Ground clearance	160 mm (6.3 in.)	160 mm (6.3 in.)	170 mm (6.7 in.)
Curb weight	(STD) 625 kg (1,378 lb.) (Deluxe) 645 kg (1,422 lb.)	(STD) 645 kg (1,422 lb.) (Deluxe) 665 kg (1,466 lb.)	(STD) 645 kg (1,422 lb.) (Deluxe) 665 kg (1,466 lb.)

Engine

Design	4 cylinder in line 4 cycle O. H. V.
Bore x stroke	73 x 59 mm (2.87 x 2.32 in.)
Displacement	988 cc (61 cu. in.)
Compression ratio	8.5 : 1
Max. B. H. P. (SAE)	62 HP at 6,000 r. p. m.
Max. torque (SAE)	8.5 m-kg at 4,000 r. p. m. (61.5 ft. -lb. at 4,000 r. p. m.)

Ignition system

Ignition timing	8° B. T. D. C. at 600 r. p. m.
Contact breaker gap	0.45 ~ 0.55 mm (0.0177 ~ 0.0200 in.)
Spark plug gap	0.7 ~ 0.8 mm (0.0275 ~ 0.0315 in.)

GENERAL SPECIFICATIONS

Fuel system	Dual barrel down draft type		
Carburetor	Dual barrel down draft type		
Lubrication	Pressured feed with full-flow type oil filter		
Cooling system	Water-cooled centrifugal pump and fan, pellet type thermostat		
Electric system	12V-40 AH Battery 12V-25 AH Alternator 12V-1.0 HP Starter Motor Negative ground system		
Transmission	All synchromesh	3-forward type	4-forward type
		1st	3.38
		2nd	1.73
		3rd	1.00
		4th	1.00
		Rev.	3.64
Rear axle	Semi-floating axle : Hypoid gear ratio		4.111 : 1 4.375 : 1 (Van)
Steering system	Recirculating ball type		
Brakes	Two leading (Front) Leading-trailing (Rear)		
Suspension			
Front	Wish bone independent type with transverse spring and hydraulic double acting type shock absorbers		
Rear	Semi-elliptic leaf springs with hydraulic double acting type shock absorbers		



GENERAL SPECIFICATIONS

Wheels and tires

		B10 and B10F	VB10
Tire size	Front	5.50-12-4P	5.00-12-4P
	Rear	5.50-12-4P	5.00-12-6P
Tire pressure	Front	1.2 kg/cm ² (17 lbs/sq. in.)	1.2 kg/cm ² (17 lbs/sq. in.)
	Rear	1.2 kg/cm ² (17 lbs/sq. in.)	1.4 kg/cm ² (20 lbs/sq. in.)

[For driving at high speeds pressures should be 0.3 kg (4 pounds) higher than above recommended pressures.]

Capacity

	B10, B10F and VB10	Liter	U. S. A. measure	Imp. measure
Fuel tank		35 (exc. VB10 series)	9 1/4 gallons	7 3/4 gallons
		30 (VB10 series)	8 gallons	6 5/8 gallons
Coolant (without heater)		3.8	4 quarts	3 3/8 quarts
	(with heater)	4.5	4 3/4 quarts	4 quarts
Oil pan		2.5	5 3/8 pints	4 1/2 pints
Oil filter		0.54	1 1/8 pints	1 pints
Transmission		0.8	1 3/4 pints	1 1/2 pints
Rear axle		0.75	1 5/8 pints	1 3/8 pints
Steering gear box		0.24	1/2 pints	1/2 pints

Datsun 1000



ENGINE and CHASSIS NUMBER

1. Engine number

Engine number is stamped on the right-hand side of the cylinder block.

Engine Model	Serial No.
A10	X X X X X X

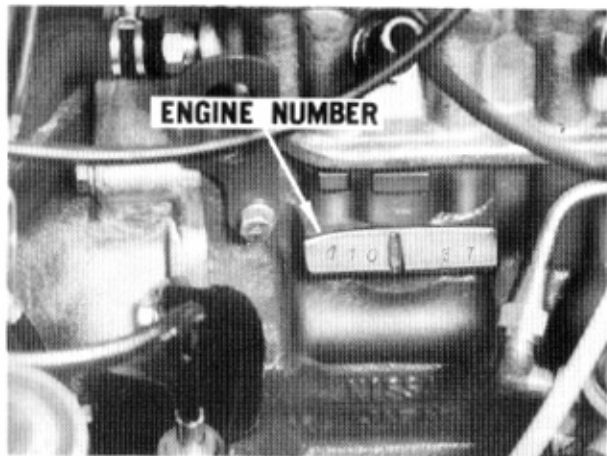

2. Chassis number

Chassis number is stamped on the right hoodedge in the engine well.

Chassis Model	Serial No.
(V)B10	X X X X X X

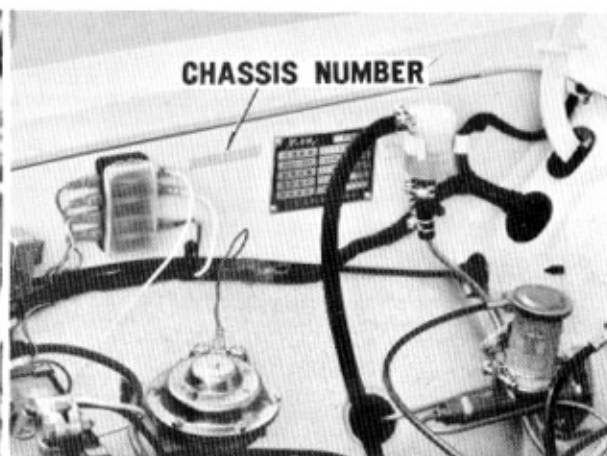

WIRING DIAGRAM

(V)B10 Series

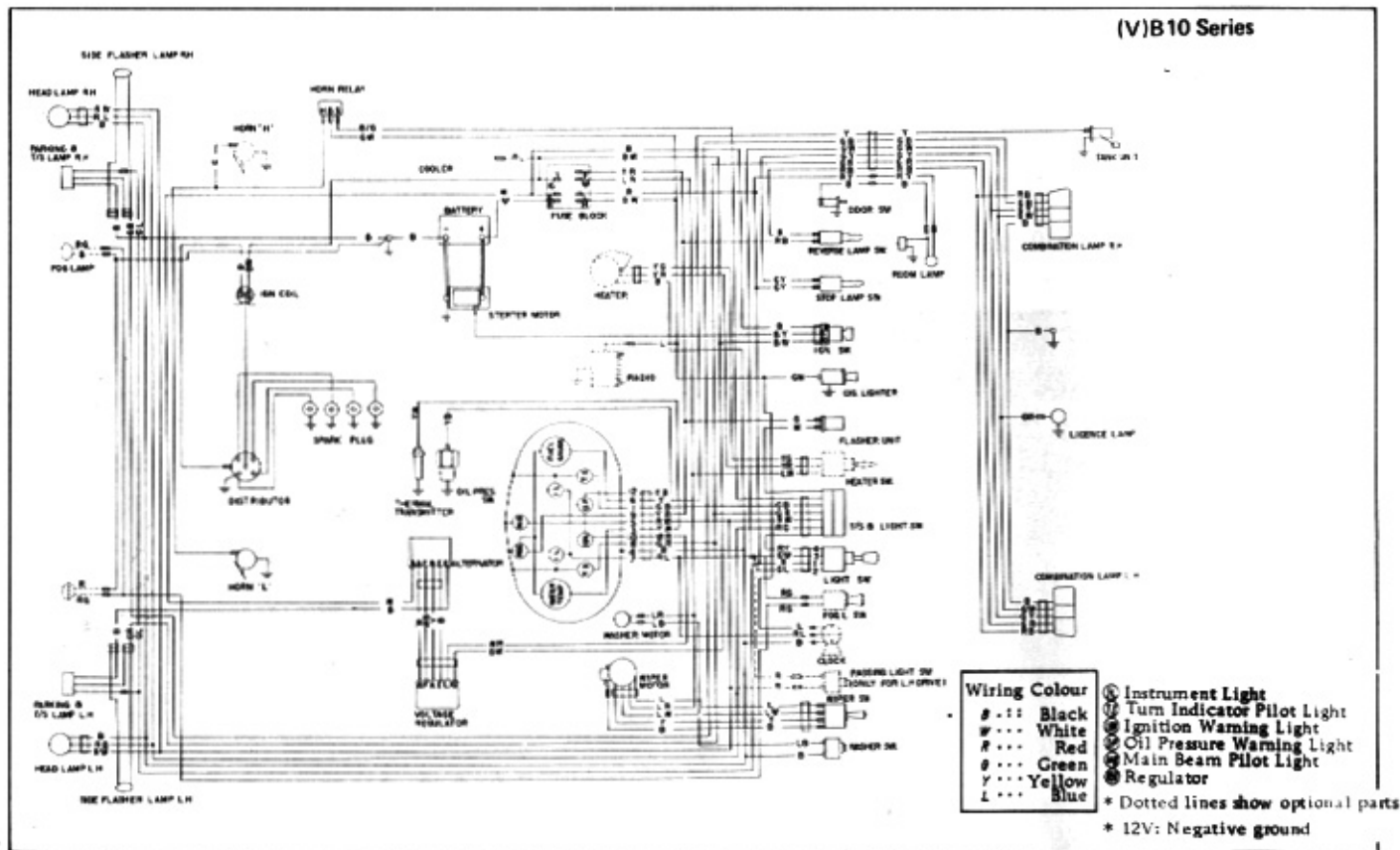

(V)LB10 (Optional wiring)

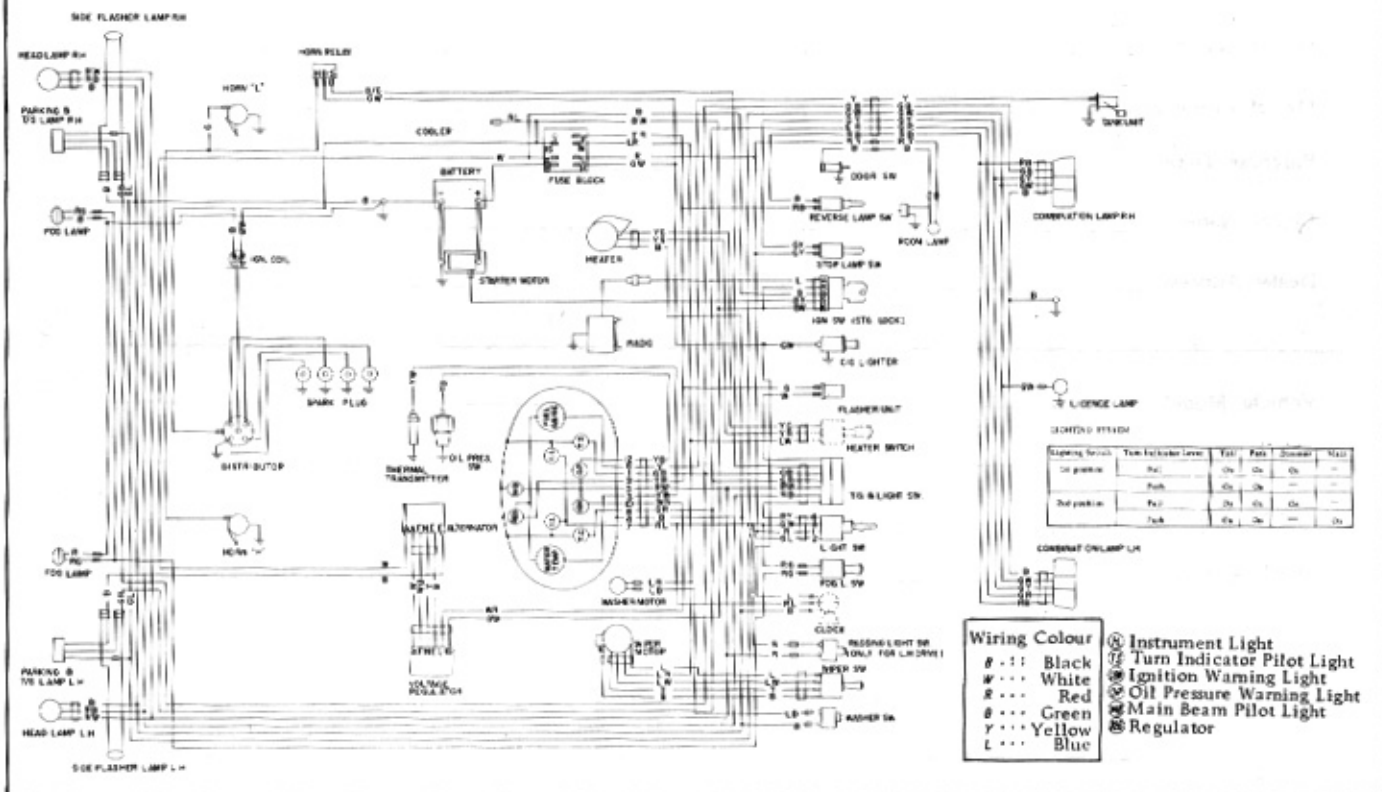

NOTE

Owner Name : _____

Owner Address: _____

Purchase Date : _____

Dealer Name : _____

Dealer Address: _____

Vehicle Model : _____

Chassis Number : _____

Engine Number : _____

Checking Date : _____



NISSAN MOTOR CO., LTD.

Printed in Japan Publication No. 19111 (40930400)